



Mini M135 Series Digital Panel Meter

- **Minimum Depth Indicator - Less than 1.25" (31.75mm) of Space Required Behind the Panel**
- **Fits 3/64 DIN Cutout, 22mm x 68mm**
- **3-1/2 Digit, 0.5" (12.7mm) High LCD**
- **User-Selectable Decimal Point**
- **Optional Negative Image, Bright Red Backlighting**
- **12 Pin Mating Connector With 6" Lead Wires Included for Easy Installation**
- **Display Hold Standard on All Units**
- **Four Voltage Ranges: 200mV, 2V, 20V, 200V**
- **Three Power Supply Alternatives: 5VDC, ±5VDC, or 9VDC (With Low Battery Indication)**



Simpson's Mini DC Voltage Indicators provide high quality, accuracy, and reliability in a compact 12mm deep case. M135 has a 3-1/2 digit, 0.5" LCD display and is available with a negative image, bright red backlight option. Mini M135s feature user-selectable decimal point and display hold.

Three power supply choices are available, and a low battery indication is provided for 9VDC battery applications. Mini units feature a standard 3/64 DIN high-impact plastic case. The standard LCD units have a clear viewing window. The units with optional negative image, bright red backlighting, have a red window.

Installation and Panel Cutout

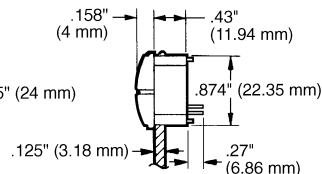
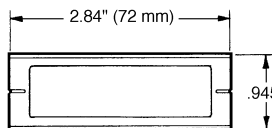
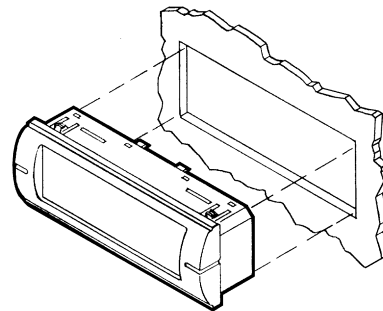
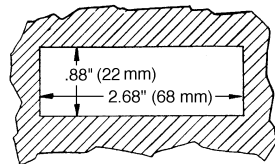
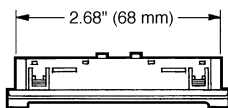

No mounting hardware required, snaps right into panel!

Mounting Requirements

The Mini indicators require a panel cutout of 2.68" (68mm) wide by 0.88" (22mm) high, and a panel area of 0.945" (24mm) high by 2.84" (72mm) wide. The depth behind the panel, including terminals, is 0.7" (17.8mm). The front bezel protrudes 0.158" (4mm) from the front of the mounting surface. The unit will snap-mount into panels from 0.050" to 0.125" thick. A 12-pin connector with 6" wire leads is included with each unit for quick installation.

Specifications

DISPLAY

Type: 7-segment LCD
Height: 0.5" (12.7mm)
Decimal point: 3-position programmable
Overrange indication: Most significant = "1"
Backlighting: Optional negative image, red backlighting at 5, 10, 12, 24, or 48VDC
Polarity: Auto with "-" indication, "+" indication implied

POWER REQUIREMENTS

DC Power: ±5V, +5V, and +9V
 (Low battery indication provided with 9V units)
Power supply current: 2mA max
Backlight supply current: 50mA typical
 For 24 and 48VDC, 10mA typical

ACCURACY @ 25°C:

±(0.1% of reading + 1 count)

ENVIRONMENTAL

Operating Temperature: 0 to 55°C
Storage Temperature: -10 to 60°C
Relative Humidity: 0 to 85% non-condensing
Warmup time: Less than 20 minutes
Temperature Coefficient: (All inputs)
 ± (0.2% of input ± 0.2 digit) /°C

NOISE REJECTION

NMRR: 60dB, 50/60Hz
CMRR: (with 1KV unbalanced @ 60 Hz): 90dB min

ANALOG TO DIGITAL CONVERSION

Technique: Integrating
Rate: 3 samples/second-typical

MECHANICAL

Bezel: 0.945" x 2.835"
 (24mm x 72mm)

Depth: 0.473" (12mm)
Panel cutout: 0.874" x 2.677"
 (22.2mm x 68mm)
Weight: 10oz (28.3g)
Case Material: 94-VO, UL rated ABS

INPUTS: DC Voltage

Range	Resolution	Input Impedance	Maximum Input (unfused)
200mV	100µV	>100MΩ	50V
2V	1mV	10MΩ	250V
20V	10mV	10MΩ	250V
200V	100mV	10MΩ	250V

Connections



These instruments are designed for maximum safety to the operator when mounted in a panel according to instructions. They are not to be used unmounted or for exploratory measurements in unknown circuits.



A reversed polarity power supply will permanently damage this instrument.



IN HIGH and IN LOW must remain within the limits of the power supply breakdown voltage.



No internal isolation is provided. Each meter requires an isolated power supply. Supply voltage must also be isolated from the circuit being measured.

A positive reading will be displayed when IN Hi is more positive than IN Low.

Internal Reference: REFOUT must always be connected to REFIN unless an external reference is being used.

External Reference: Connect between REFIN and ANALOG GROUND; REFOUT should then be unconnected (open). For best results, external reference voltage should be in the range of 50mV to 150mV. System stability is then only as good as the external reference.

Calibration

Model M135 has a limited range adjustment for calibration. Apply the appropriate current input for a near full scale reading, typically 1900 counts on the display. The adjustment is accessed through the exposed hole in the upper left corner of the rear panel. For this adjustment to function, REFOUT must be connected to REFIN.

Backlight Power Supply

A 2-pin connector is included with the unit if backlighting is specified. The right pin is the Positive, and the left pin is for the Negative power supply. See the Rear Connections diagram for location.

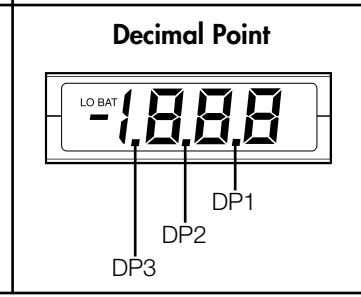
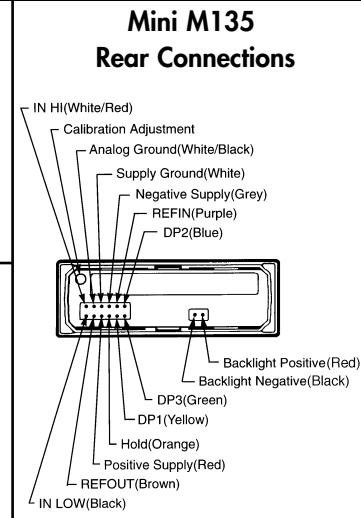
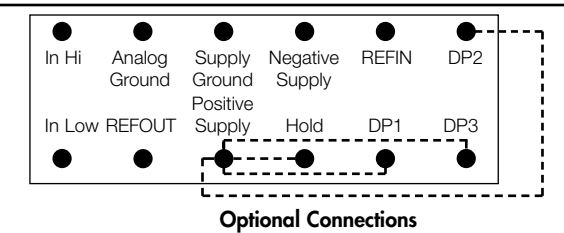
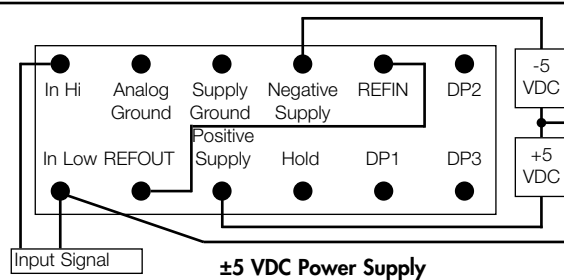
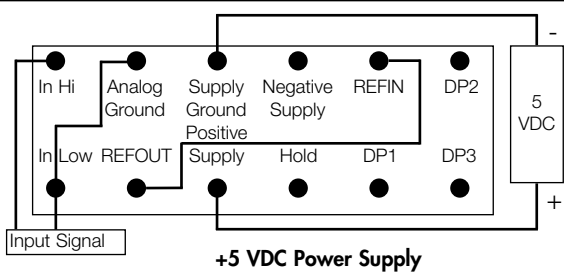
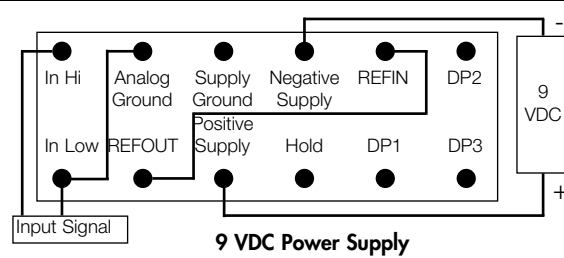

Decimal Point: DP 1 is the first decimal point to the left of the least significant digit. Connect DP# to Positive Supply to activate. Unneeded features should remain unconnected.

Display Hold: The display can be held indefinitely by connecting Hold to Positive Supply. The display will function normally when this connection is removed.

Safety Symbols



The WARNING sign denotes a hazard. It calls attention to a procedure, practice, or the like, which, if not correctly performed or adhered to, could result in personal injury.



The CAUTION sign denotes a hazard. It calls attention to an operating procedure, practice, or the like, which, if not correctly adhered to could result in damage to or destruction of part or all of the instrument.

Ordering Information

Mini Voltage Indicators can be configured by making an entry for each box

