



Falcon F35 Series Digital Panel Meter

- Full 3-1/2 Digit, Bright Red 0.56" (14.2mm) Display
- Broad Range Display Scaling
- Short 2.94" (74.7mm) Deep, 1/8 DIN Case
- Screw Terminal Connector for Easy Installation
- Four User-Settable Ranges: 200mA, 2mA, 20mA, 200mA
- Two Factory-Settable Ranges: 2A, 5A
- Jumper-Selectable Decimal Point
- Optional Isolated 9-32VDC Power Supply
- Optional Excitation Output of 12VDC or 24VDC



The Falcon Series digital indicators are premium quality 1/8 DIN meters for industrial applications. All Falcon units feature jumper-selectable decimal point (internal and on the connector for remote decimal point) and display scaling, providing wide application flexibility. In addition, most signal input ranges are easy to change with jumpers on the main board. The Falcon has a 0.56" bright red LED display for high visibility.

Compactly designed for applications requiring minimal rear panel depth, the Falcon fits a standard 1/8 DIN panel cut-out (91.9mm x 45mm) and requires less than 3" behind the panel. A screw terminal connector is a standard feature for easy wiring of the power supply and signal input connections.

Installation and Panel Cutout

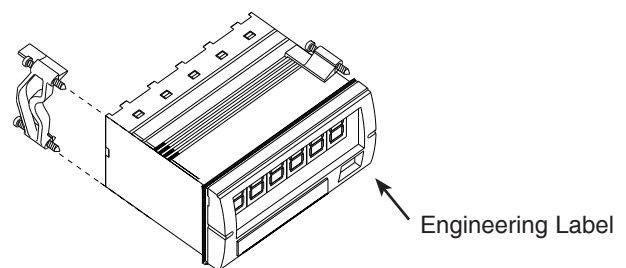
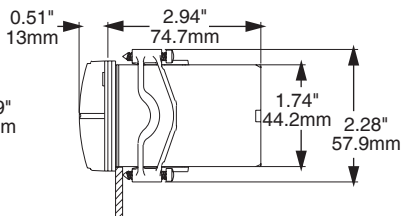
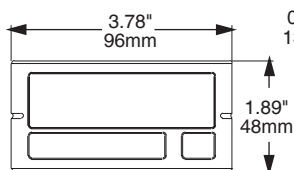
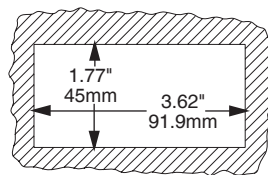
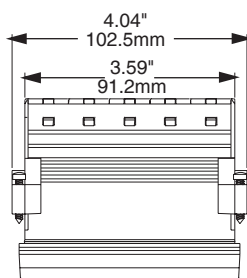

Mounting Requirements

The Falcon series 1/8 DIN indicators require a panel cutout of 1.77" (45mm) high by 3.62" (91.9mm) wide. To install the Falcon into a panel cutout, remove the clips from the side of the meter. Slide the meter through your panel cutout, then slide the mounting clips back on the meter. Press evenly to ensure a proper fit.

Engineering Label Placement

If replacement of the engineering unit label is required, place the tip of a ball-point pen into the small hole at the base of the engineering label in the bezel. Slide the label up until it pops out. Grasp and remove. Slide the new label half the distance in, then use the ball-point pen to slide it down into place.

Specifications

DISPLAY

Type: 7-segment, red LED
Height: 0.56" (14.2mm)
Decimal Point: 3-position programmable, internally or on the terminal block
Overrange indication: most significant digit = "1"; other digits blank
Polarity: Automatic, with "-" indication, "+" indication implied

POWER REQUIREMENTS

AC Voltages: 120 or 220VAC, ±10%
 50/60Hz
DC Voltages: 9-32VDC, ±1%
Power Consumption: 3VA

ACCURACY @ 25° C

±0.1% of reading ±1 count
 2A ± 5 counts
 5A ± 5 counts

ENVIRONMENTAL

Operating Temperature: 0 to 55°C
Storage Temperature: -10 to 60°C
Relative Humidity: 0 to 85% non-condensing
Temperature Coefficient:
 (±0.01% of input ± 0.05 count)/°C
Warm-up Time: Less than 15 minutes
Response Time: Less than 1 second

NOISE REJECTION

NMRR: 50dB, 50/60Hz
CMRR: (with 1KΩ unbalanced @ 60Hz):
 90dB min.

ANALOG TO DIGITAL CONVERSION

Technique: Dual slope integration
Rate: 3 samples per second, nominal

MECHANICAL

Bezel: 3.78" x 1.89" x .51"
 (96 x 48 x 13mm)
Depth: 2.94"(74.7mm)
Panel Cut-out: 3.62" X 1.77"
 (91.9 x 45mm, 1/8 DIN)
Case Material: 94V-1, UL rated Noryl®
Weight: 9.0oz (255.1g)

INPUTS: DC Current

Input Range	Display Resolution	Maximum Input	Voltage Drop
200µA	100nA	10mA	200mV
2mA	1µA	40mA	
20mA	10µA	100mA	
200mA	100µA	500mA	
2A	1mA	2.2A	
5A	10mA	5.2A	

Wiring Diagram

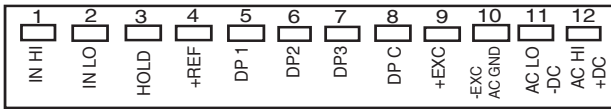

Input Signal: Connect the signal to be monitored to the IN HI and IN LO terminals. IN HI is terminal #1, IN LO is terminal #2.

Supply Power: Connect the supply power to terminals #11 and #12. Note that if AC power is supplied, terminal #11 is for Neutral, and terminal #12 is for Hot. If DC power is used, terminal #11 is for -DC, and #12 is for +DC.

Display Hold: This feature allows you to hold the displayed value indefinitely. A remote switch can be used to make the connection. To activate the display hold, short pins #3 and #4 (Hold and +REF). This connection must be kept isolated from other circuitry. To hold multiple units, separate poles of the switch must be used to maintain the isolation.



These instruments are designed for maximum safety to the operator when mounted in a panel according to instructions. They are not to be used unmounted or for exploratory measurements in unknown circuits.



Before switching the instrument on, make sure the supply voltage matches the power source required of the instrument as indicated on the hook-up label affixed to the instrument.

Decimal Point Selection

From terminal block: The decimal point can be set from the rear screw terminal block by connecting the appropriate decimal point (DP 1, 2, 3,) to the DP C terminal. The J105 jumper must be in the D position (see diagram under "From front panel").

Decimal Point	Connect
1.999	DP C to DP1
19.99	DP C to DP2
199.9	DP C to DP3
1999	No Decimal

From front panel: The decimal point can also be selected by removing the front bezel from the meter. Move the push-on jumper J105 across the correct letter.

Decimal Point	Jumper Position at J105__
1.999	A
19.99	B
199.9	C
1999	D*
	* No Decimal Point

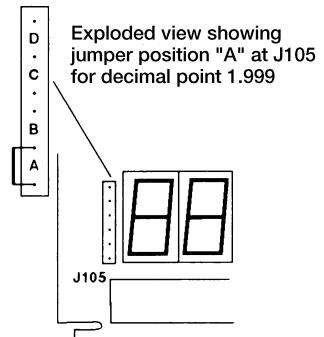

Current Range Selection

All Falcon Indicators are configured initially per the customer specifications. Range changes can be accomplished as follows:

Disconnect power from the unit. Remove the unit from the panel. Remove the front bezel by inserting slotted screwdriver in the vertical slots on either side of the bezel and then turning to pry the bezel off. Unscrew the two Phillips head screws at either side of the circuit board. Finally, push on the green connector assembly in the back of the unit to slide the main circuit board out from the meter. Change jumpers according to the chart below.

Note: If a new range is selected, the calibration procedure must also be performed.

Input Range	J102	J106	JU101	JU102
200µA	A	R	A	No
2mA	B	R	A	No
20mA	D	R	A	No
200mA	E	R	A	No

If you need to change a Falcon from (or to) a 2 amp or 5 amp unit, please consult the factory or an Authorized Service Center.

Note: JU101 and JU102 are hard wire jumpers, and are removed by cutting them. Resoldering the JU jumpers is not recommended. If this is required, or if a function is to be changed (from volts to current), Simpson recommends returning the Falcon to the factory or an Authorized Service Center. After moving the jumpers to the desired location, put the Falcon back together and install in your panel, or proceed to calibration.

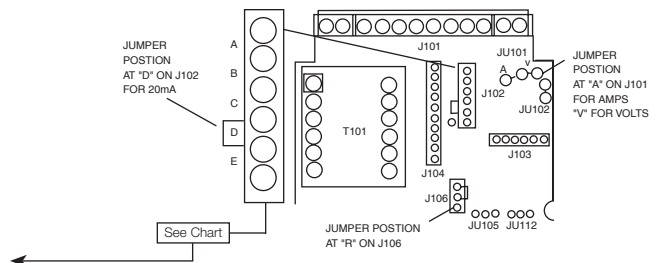

Display Scaling

The Falcon can be easily scaled for a broad range of engineering units. The meter may be scaled up to two times, or down to 1/5 the value of the input.

- 1) Remove the front bezel with a small screwdriver.
- 2) Apply the full scale input to the meter.
- 3) Adjust the potentiometer VR101 located on the right side the display board to the desired scaled value.
- 4) Replace the bezel carefully. A card of labels is provided for alternative engineering units, such as percent.

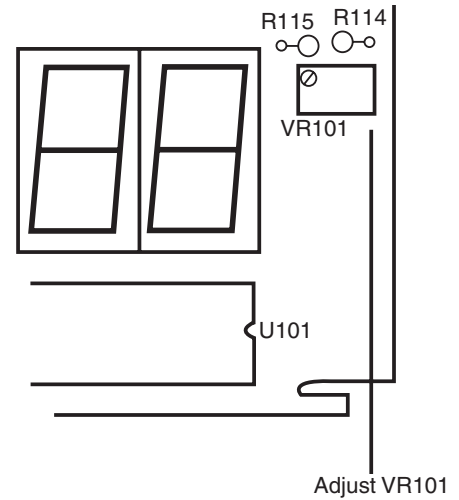

Calibration

The Falcon is calibrated at the factory per order. If you change the range, and have moved the jumpers, your Falcon will need to be recalibrated.

- 1) Remove the bezel with a small screwdriver.
- 2) Apply an input signal to the connector.
- 3) Adjust the potentiometer (VR101) located on the right side of the display board until the display indicates the value of the input signal or desired display value. For example, if a 19.99V signal is applied, adjust the potentiometer until the display indicates 19.99 (V).
- 4) Replace the bezel carefully, and install the meter.

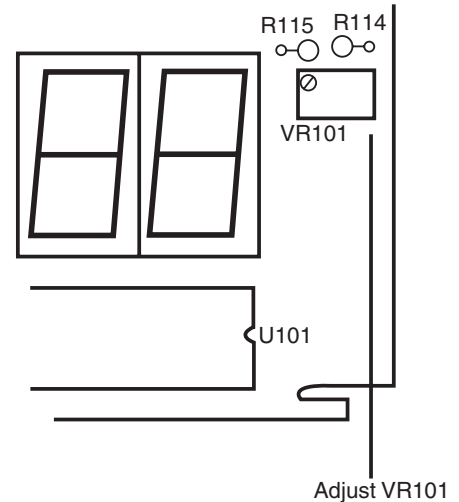

Excitation Output

An optional feature of the Falcon is the 12VDC or 24VDC Excitation output. The Falcon is set at the factory per your order to include an Excitation plug-in printed circuit board in the range you specify. Excitation supply allows you to power external transformers and transducers without having to set up additional DC power sources for them.

If your application changes, you can easily change the Excitation value. The Excitation supply can be reconfigured by moving push-on jumper J201 (located on the Excitation board). To change the Excitation output value, move the jumper to the correct position shown in the diagram.

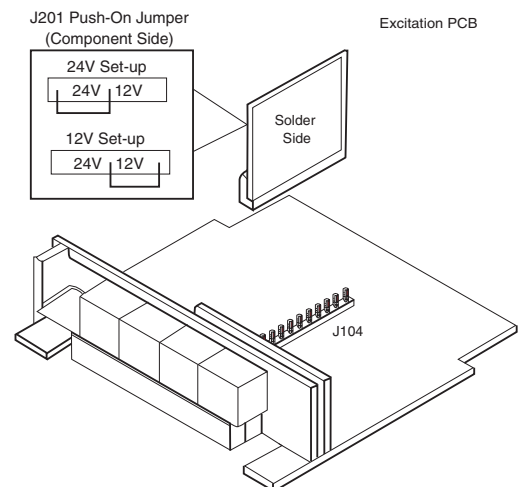

Application Example

A plant manager needs to monitor the current draw of two machines from one DC power source. The first machine is rated at 200mA and the second machine is rated at 10 amps.

The first machine can be monitored with a Falcon 200 DCmA meter. The meter is installed in series between the source and the load. No additional scaling is required for this meter.

The second machine requires a portable shunt (10 amps/50mV) and a Falcon 200 DCmV meter. The second meter needs to be scaled before being installed into the panel. A 50mV signal must be applied to the Falcon (full strength signal from the shunt). Next, remove the front bezel, and adjust potentiometer VR101 until the display indicates 10.0 amps. Replace the bezel, and remove the signal.

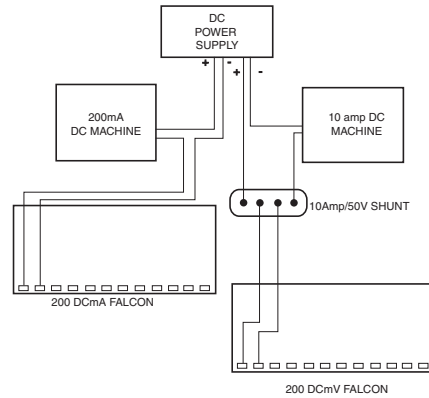

The shunt is installed in series between the source and the load, and the meter is connected to the shunt in parallel. The two lead wires included with the shunt are connected

to terminals #1 and #2, located on the rear of the Falcon. Be sure to place a jumper across R114 when using a 10 amp/50mV shunt.

Ordering Information

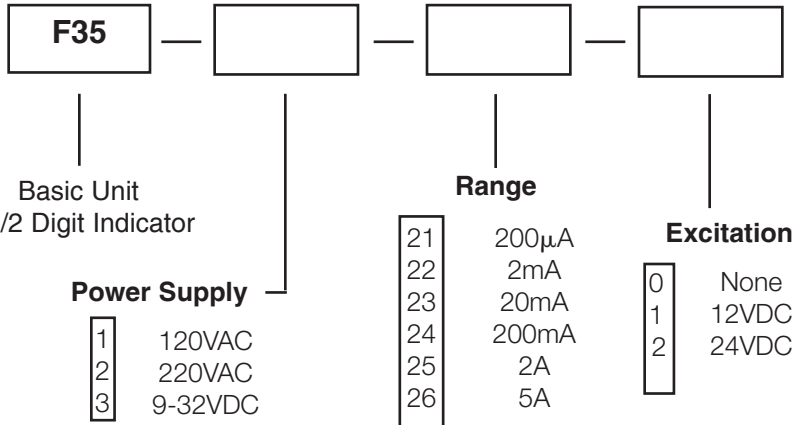

Safety Symbols



The WARNING sign denotes a hazard. It calls attention to a procedure, practice, or the like, which, if not correctly performed or adhered to, could result in personal injury.



The CAUTION sign denotes a hazard. It calls attention to an operating procedure, practice, or the like, which, if not correctly adhered to, could result in damage to or destruction of part or all the instrument.

Accessories

Switchboard

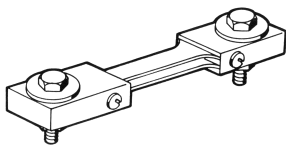

External shunts enable DC volt digital panel meters to indicate higher DC currents than can be provided with self contained internal shunt meters. The shunt is installed in series with the load and the source. The shunts provide a DCmV drop which is sent to the display unit. The Falcon can be scaled to display the current between the load and the source. Simpson manufactures portable and switchboard shunts.

Portable

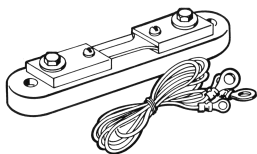

Each shunt includes 5' leads (0.065Ω resistance). Accuracy is within ±1% of rating.

Portable Shunts (50 mV)

Amps	Cat. Number
1	06700
5	06703
10	06704
15	06705
25	06707
30	06708
50	06709
75	06711
100	06713
150	06714
200	06715
10A 100 V	06716
10A 200V	06717

Switchboard (50 mV)**

Amp	Voltage Drop	Catalog Number
100	50	06500**
150	50	06503**
200	50	06504**
250	50	06505**
300	50	06506
400	50	06507
500	50	06508

A portable and/or switchboard shunt should be used with Falcon Series 200 mVDC meters. Specifications can be found on data sheet for DC voltage.